

abplanalp

Through-Process Production Surface Grinding Machine CES

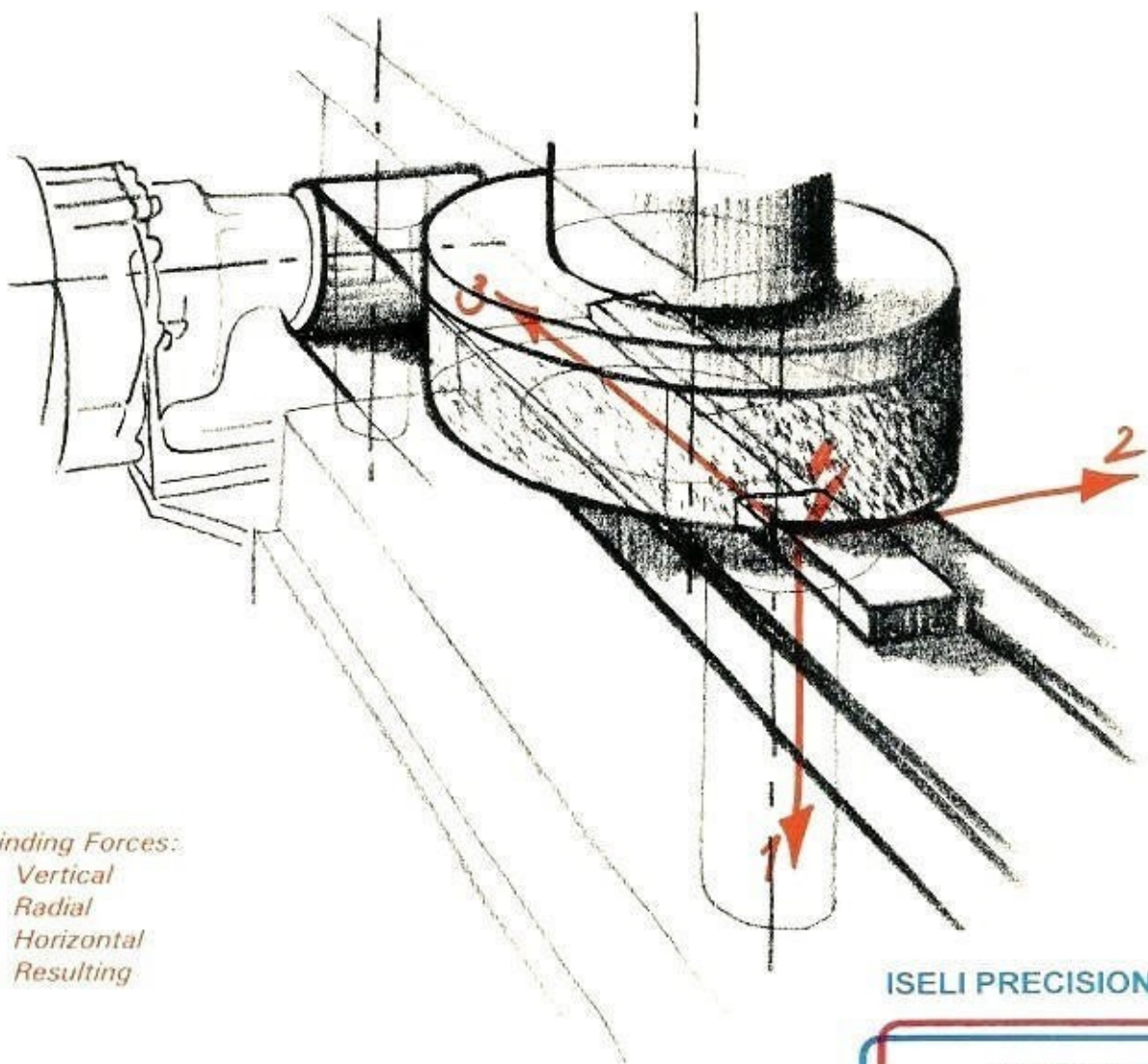

Grinding Forces:

1. Vertical
2. Radial
3. Horizontal
4. Resulting

ISELI PRECISION INC. 

1405 MEGHAN AVENUE
ALGONQUIN, IL 60102

PH. 847-516-1110
FAX: 847-658-1615

www.iseliprecision.com
grinders@iseliprecision.com

The Concept

The Abplanalp Through Process Grinding Machine Type CES and the grinding concept are patented. The workpieces are conveyed under a horizontal grinding wheel and are ground on the top surface. Underneath the continuously moving conveyor band with variable speed is a magnetic chuck. Its purpose is to hold the workpieces down during the grinding process as well as to aid in containing the grinding forces during heavy stock removals. The majority of the grinding forces are taken by a guide rail in the longitudinal direction which permits high stock removal rates. The sum of these grinding forces also allows non-magnetic parts to be ground with normal stock removal rates and without holding devices.

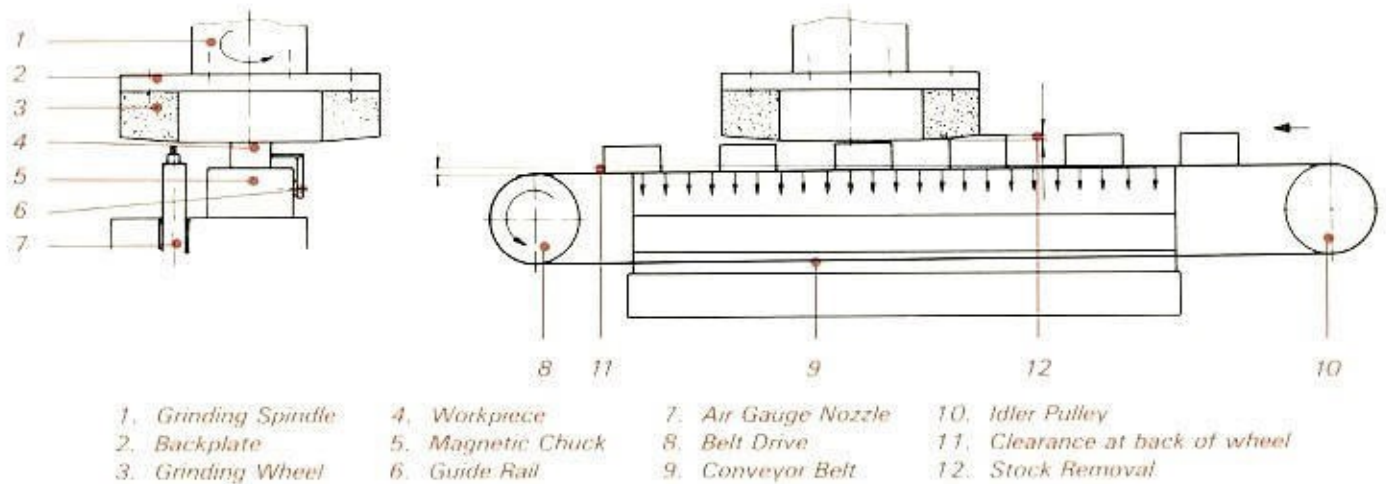

Applications

Workpieces with a small width can be ground next to each other in parallel guide rail channels. Because of the continuous grinding process, this machine is particularly suitable for mass production.

Grinding Wheel

The grinding wheels which can be used in this machine are resin bonded silicon carbide or aluminium oxide wheels, borazon CBN or diamond grinding wheels.

Belt Drive Systems and Conveyor Belts

Different types of conveyor belts are used, depending on the application. In most cases, a conventional abrasive belt with a wet/dry abrasive coating is used and in some cases plastic coated or metal belts are substituted. In applications where workpieces require a very tight thickness tolerance or parallel tolerances, the abrasive top surface of the conveyor belt is specially ground.

The belt drive system consists of a 1.2 kW (2 HP) drive motor, gear box and pulleys. The belt speed is infinitely variable up to 10 m/min. (393.7 inches/min.).

Magnetic Chucks

Depending on the application, electro-magnetic or permanent magnetic chucks with different dimensions and pole steps are used. The top surface of the magnetic chuck is protected by a wear plate made from hardened, blue-tempered steel. With long magnetic chucks, the magnetic power can be reduced by additional wearplates before and after the grinding area.

Style 1

Magnetic chucks with a constant taper from one end to the other result in a slight hollow grind. The amount of taper can be tailored to the application. Length of workpieces: Unlimited.

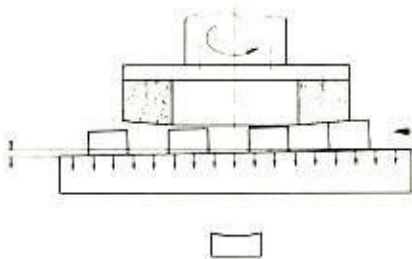

Style 2

Magnetic chuck with the first part perpendicular to the grinding wheel axis. The second is ground in a taper to allow clearance on the back of the grinding wheel. The maximum workpiece length cannot exceed the grinding wheel ID radius.

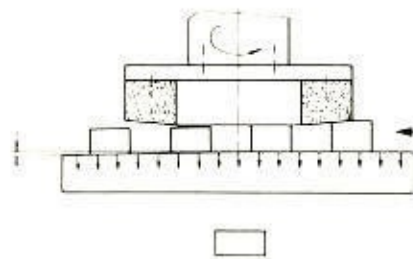

Style 3

Magnetic chucks with a ground in taper on entrance as well as exit side. The result is a slightly convex grind. The amount of chuck taper can be tailored to the applications. The maximum workpiece length cannot exceed the grinding wheel ID radius.

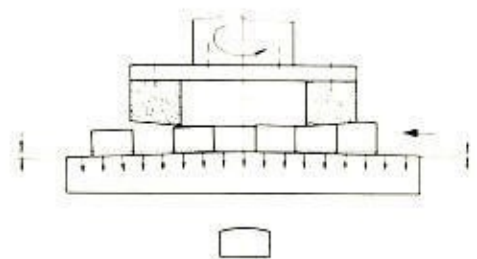

Large production lots and mass production require a new approach to modern grinding machine development

Adaptation to the Application

The design of the continuous Through Process Surface Grinding Machine Type CES is conceived and planned as a modular group. The individual groups such as machine base, belt drive system, wheelhead and grinding spindles allow a combination to suit the particular production requirements and applications.

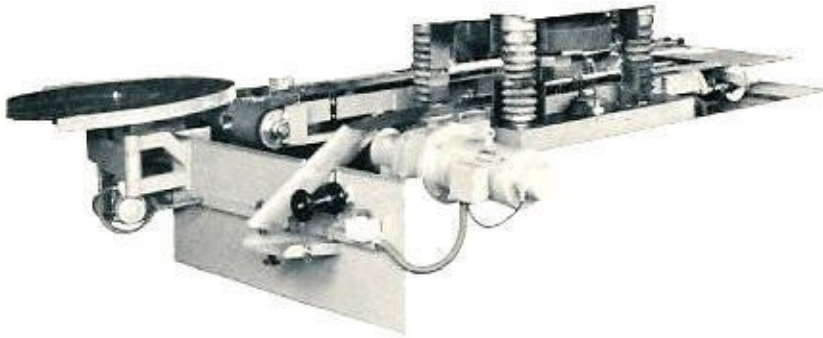

Shown is the rotary return table swivelled out of the way and the discharge chute installed.

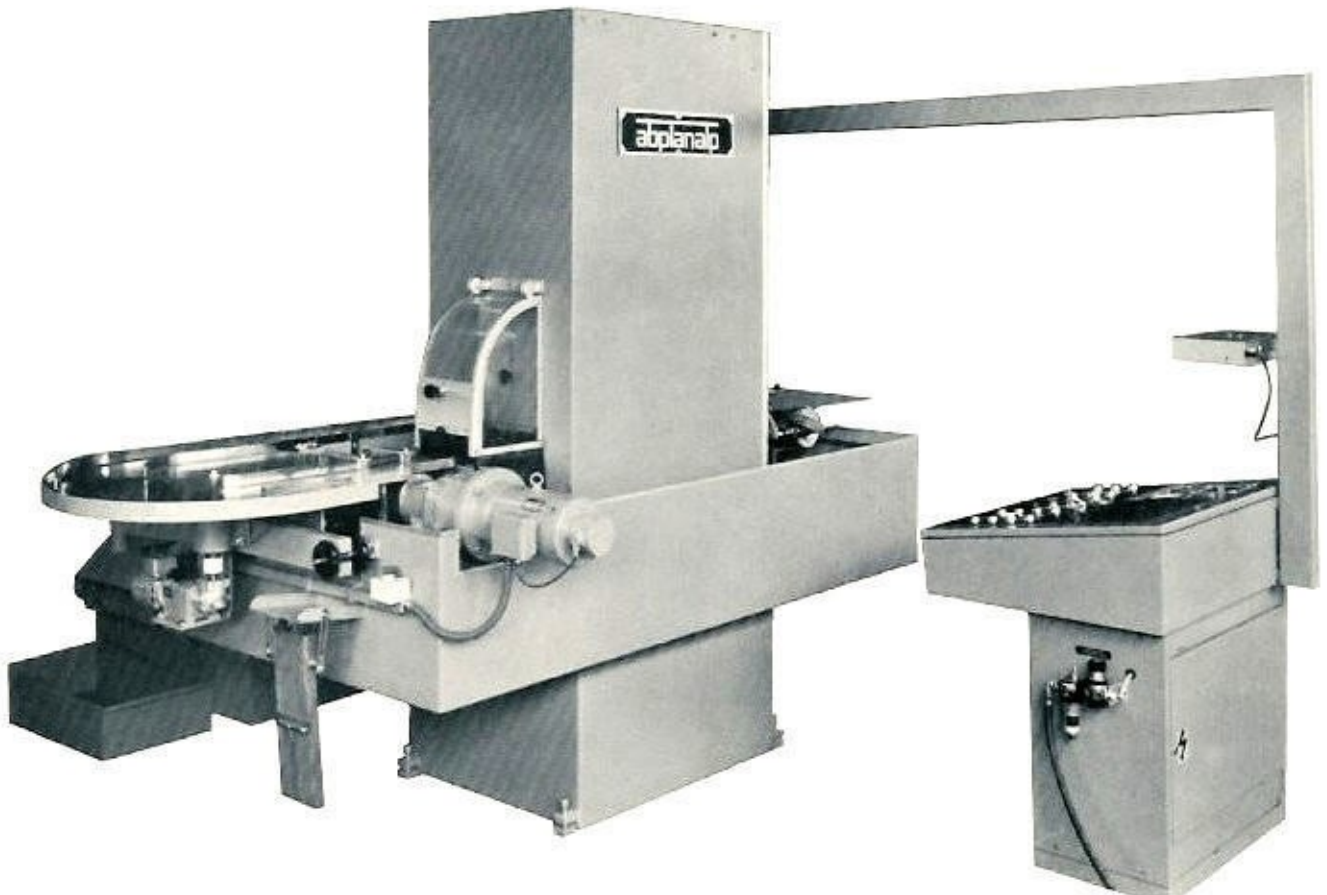

Shown is the grinding machine with automatic return of the workpieces to the operator's side. This system is used where workpieces are very delicate or require grinding in fixtures.

Safety and Operation

The guard can only be opened when the grinding wheel is stopped. All controls and monitoring instruments are centrally installed in the operator's panel. Logical interlocks prevent operator errors. For this reason, Abplanalp Production Surface Grinding Machines of the Type CES are specifically suitable for large production runs without the need for highly qualified operators.

High Rigidity and Stock Removal

Heavy and compact construction modules with the necessary rigidity results in high stock removal capabilities and are a feature of the design of the machine Type CES.

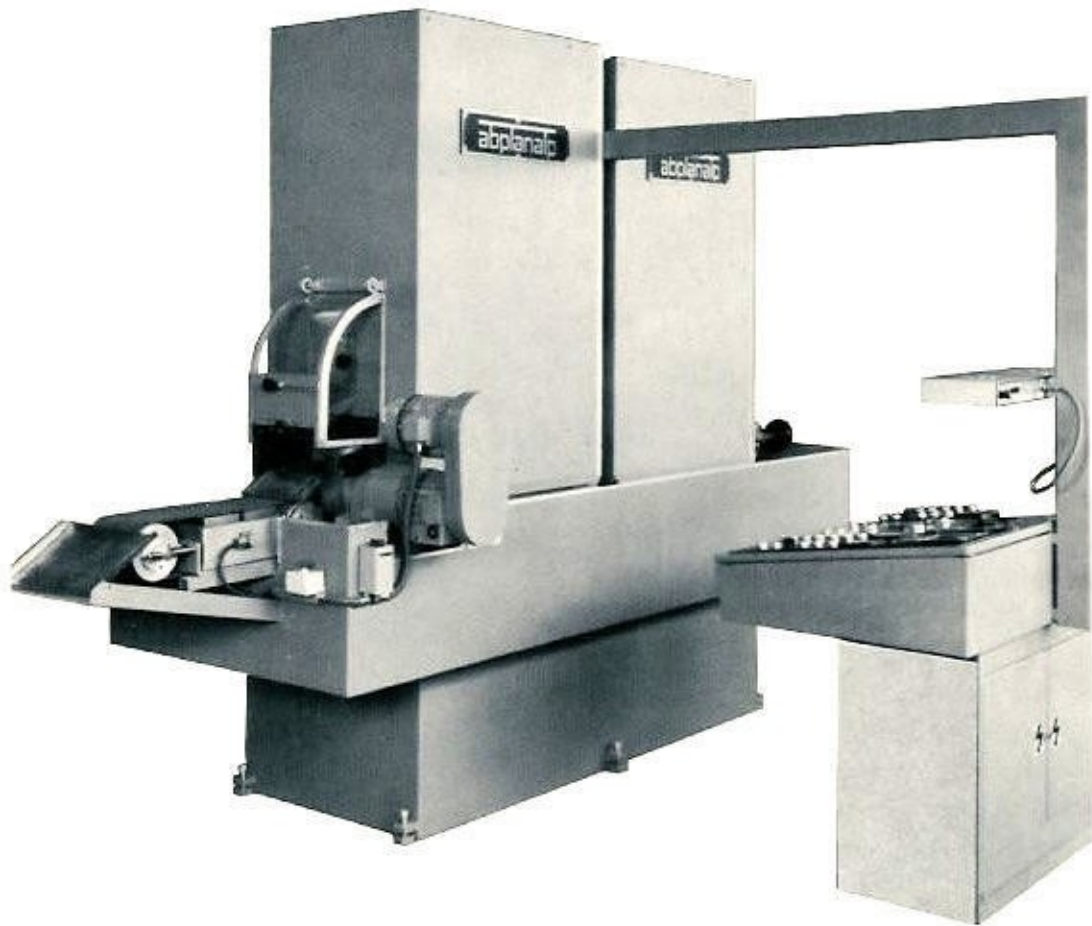

Machines with two grinding heads can be used for various applications, such as roughing and finishing or slotting and profiling in one pass through the machine.

Compensation Control

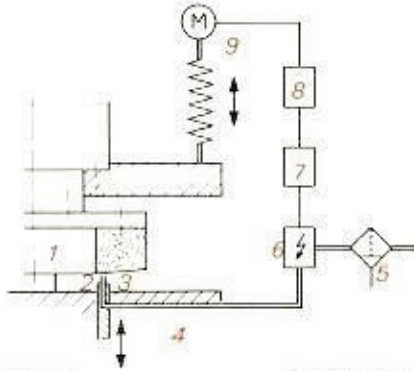

- | | |
|--------------------------------|----------------------|
| 1. Grinding Wheel | 6. Converter |
| 2. Workpiece | 7. Measuring Unit |
| 3. Air Gauge Nozzle | 8. Signal Output |
| 4. Air Gauge Nozzle Adjustment | 9. Positioning Motor |
| 5. Air Filter | |

Air Gauge Adjustment System

The air gauge is adjusted by a hand wheel with a graduated dial.



Grinding Wheel Wear Compensation

An air gauge nozzle is adjusted to the finished workpiece height. A different nozzle is used for dry or wet grinding. It senses back pressure variations from the adjusted gap (workpiece height). With the corresponding signals, the grinding wheel is constantly monitored and adjusted to its respective position. This will compensate for grinding wheel wear and also for variations in heat expansion of the machine tool.

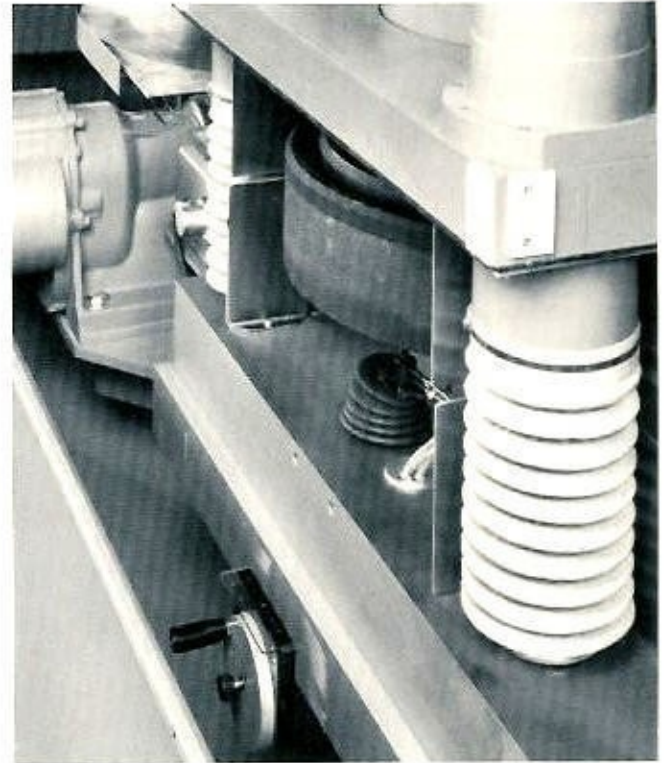

Digital Readout System

1. Digital readout system continuously monitors the grinding wheel position and has a pre-selectable manual number insert.
Resolution: 0,005 mm (.0002'').

Air Gauge Control Unit

2. To monitor grinding wheel wear, a meter and light unit is provided.
Minimum compensation: 0,005 mm (.0002'').
3. Ampere meter for grinding spindle motor lead.

Independent Grinding Wheel Wear Compensation Unit

The grinding wheel head is an independent module of the machine with a fully-integrated downfeed and compensation system. The over-dimensioned ball cages, pins and bushings of the die set assure utmost rigidity in the downfeed direction and insure maximum stock removal capabilities. High precision satellite screw positioning of the grinding wheel head driven by a highly over-dimensioned timing belt and DC motor establish an absolutely parallel and extremely sensitive movement of the grinding wheel head.

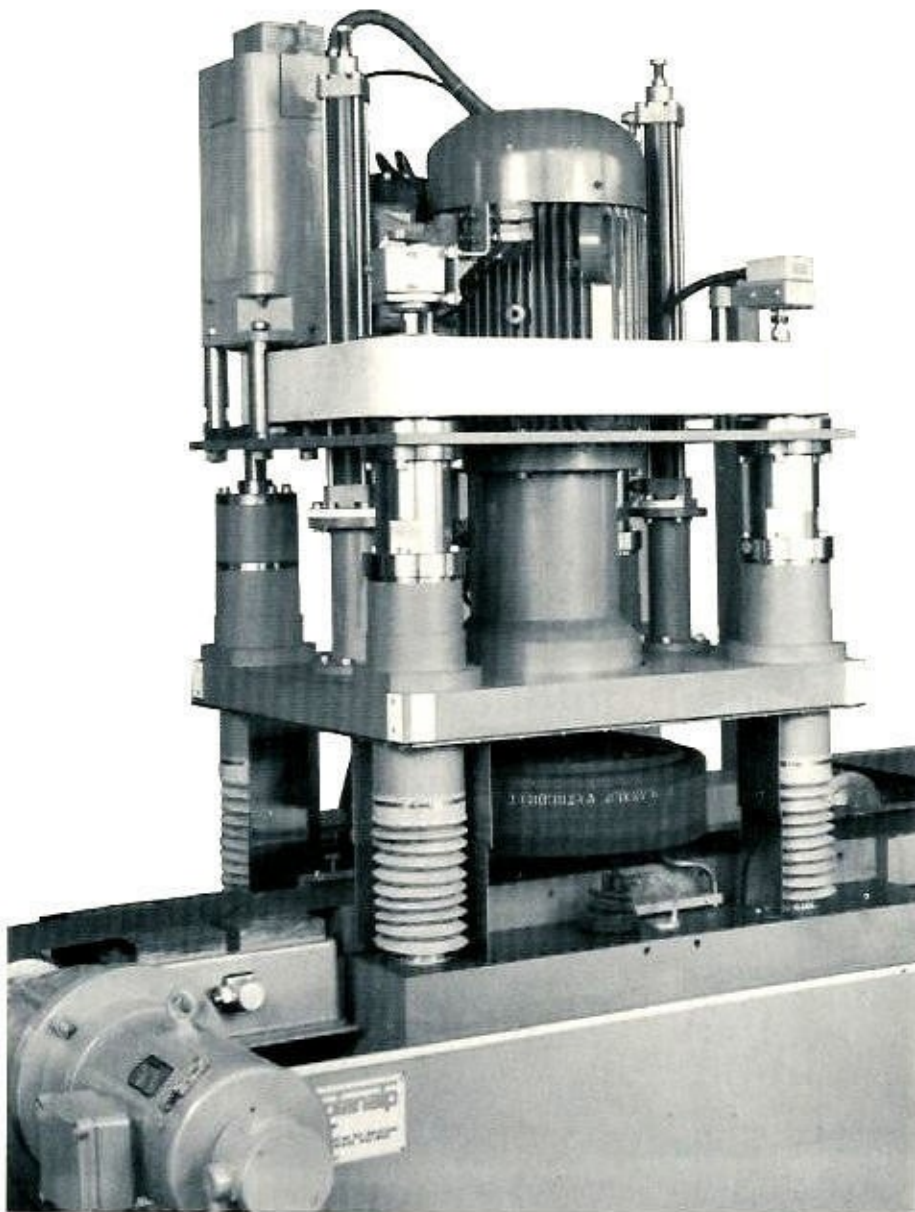

Compensation Unit electronically and mechanically controlled



Grinding Spindle

The grinding spindle is of rigid ball bearing design. Since a production grinding machine has different requirements regarding the spindle design, several different spindles as well as drive motors are available. By maintaining the same mounting patterns and adaptors, interchangeability is assured.

The grinding spindle is permanently lubricated with grease and does not require any maintenance. To stop the grinding spindle, an electronic grinding spindle brake is available.

Grinding with Holding Fixtures

Grinding fixtures are required when the workpieces cannot be placed directly on the conveyor belt.

Automatic Loading

Because our customers are increasingly interested in «TURN-KEY» systems for production grinding, we are prepared to provide complete loading and unloading systems for any applications.

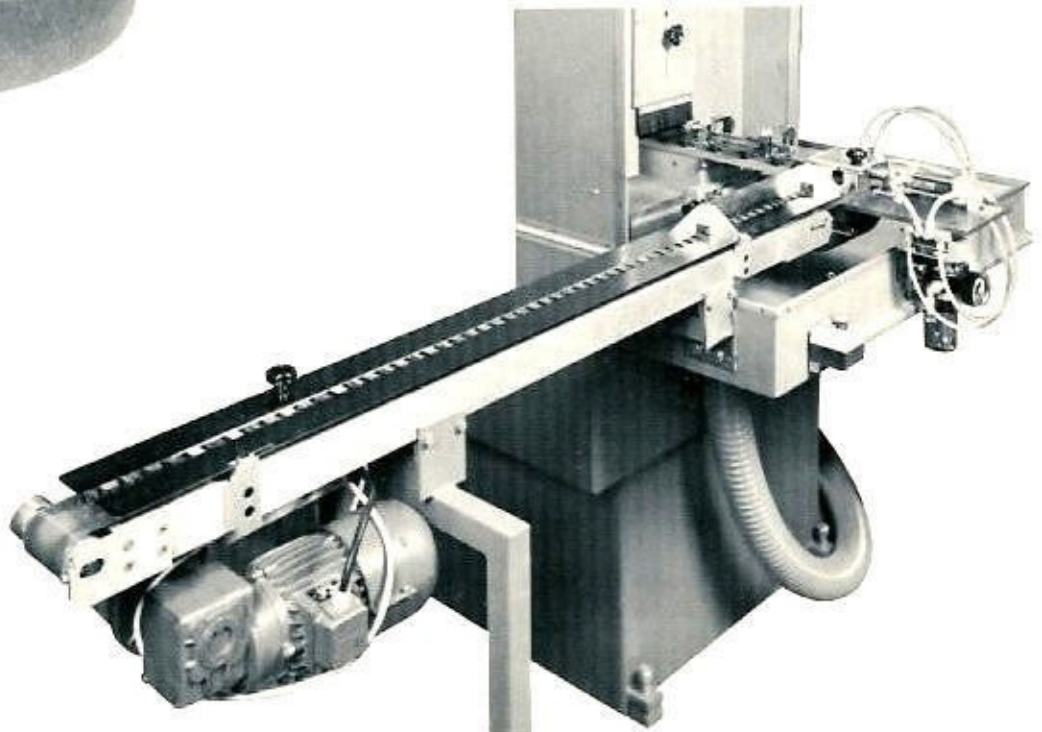

Electronically and mechanically controlled machine

Technical Data

| | | |
|------------------------|--|--|
| Machine Capacity | Width | 150 mm (6'') 200 mm (8'') 250 mm (10'') 300 mm (12'') |
| | Height | 150 mm (6'') |
| | Length | Unlimited |
| Grinding Spindle | Motor | up to 30 kW (40 HP) |
| | Spindle speed | up to 3600 RPM |
| Wheelhead | Range | max. 300 mm (12'') |
| Mechanical positioning | | max. 800 mm/min. (31''/min. adjustable) |
| | | Fine 0.33 mm/min. (.013''/min. inf. adjustable) |
| Belt Drive System | Motor | 1.2 kW |
| | Belt speed | 0 - 10 m/min. (0 - 393''/min.) (Infinitely variable) |
| Electrics | Power Requirements | 380 V 50 Hz (230/460/3/60 Hz) |
| | Power consumption depending on machine equipment | up to 50 kW (66 HP) |
| | Control voltage | 110 volts |
| Pneumatic | Air pressure | 6 bar (60 PSI) minimum |
| Standard Equipment | Grinding spindle with motor | |
| | Automatic wheel wear compensation | |
| | Air gauge adjustment system | |
| Accessories Available | Belt drive system with SCR motors | |
| | Grinding spindle motors with various horsepower | |
| | Grinding spindle brake | |
| | Magnetic chucks | |
| | Conveyor belts | |
| | Demagnetizing systems | |
| | Coolant systems | |
| | Dry grinding attachments | |
| | Turnover systems | |
| | Return conveyor systems | |
| | Automatic loading systems | |
| | Wheel load dependent belt speed systems | |
| | Automatic balancing unit | |

Electronically and mechanically controlled machine

Type CES 1/150/4S
 =====

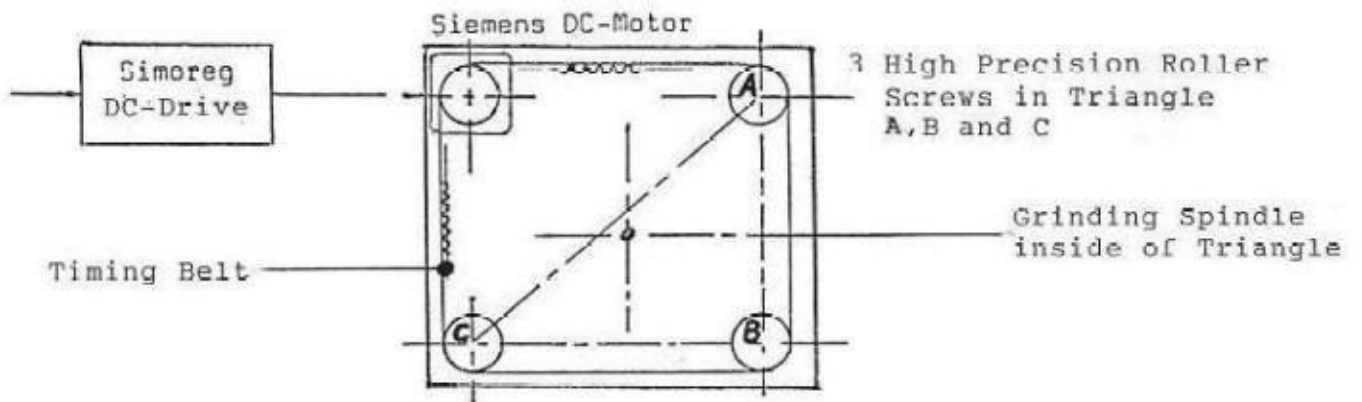
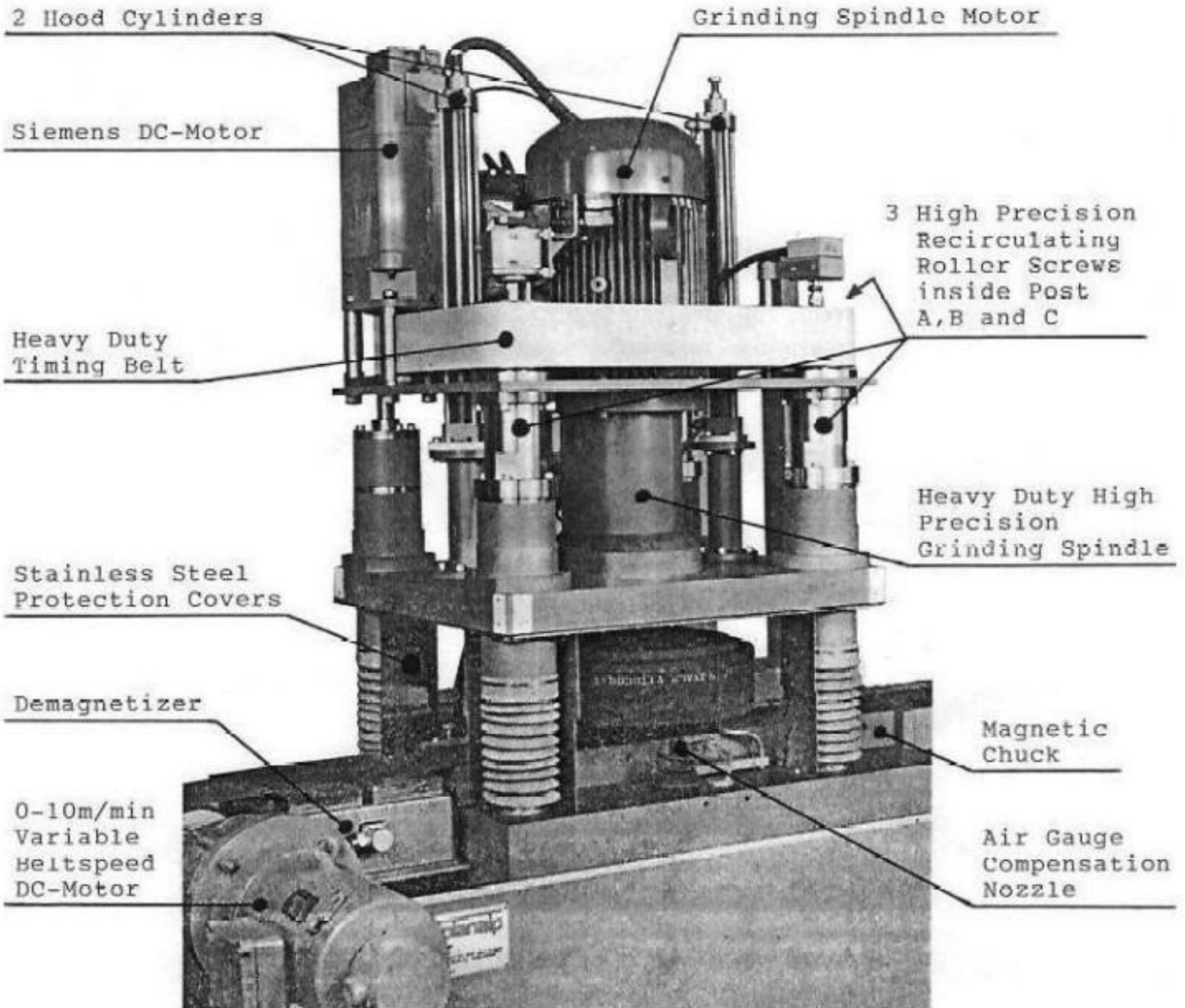

Recirculating roller screws

SV/PV roller screws allow very accurate positioning together with high rigidity. These features facilitate simplification of the complete transmission as well as improvement of its performance. The mechanism is very robust, has a long life and is more reliable than a miniature ball screw.

SV: screw nut assembly with axial play

PV: preloaded screw nut assembly.

Specific advantages recirculating roller screws

- * Leads as small as 1 mm
- * Resolutions of 0,025 μ have been achieved
- * High load carrying capacity because many strong contact points share the load
- * Long life
- * More robust and reliable than a miniature ball screw.
- * High efficiency
- * Smooth action – no stick slip
- * Excellent repeatability
- * High reliability
- * Predictable life
- * Low wear ensuring consistent precision.

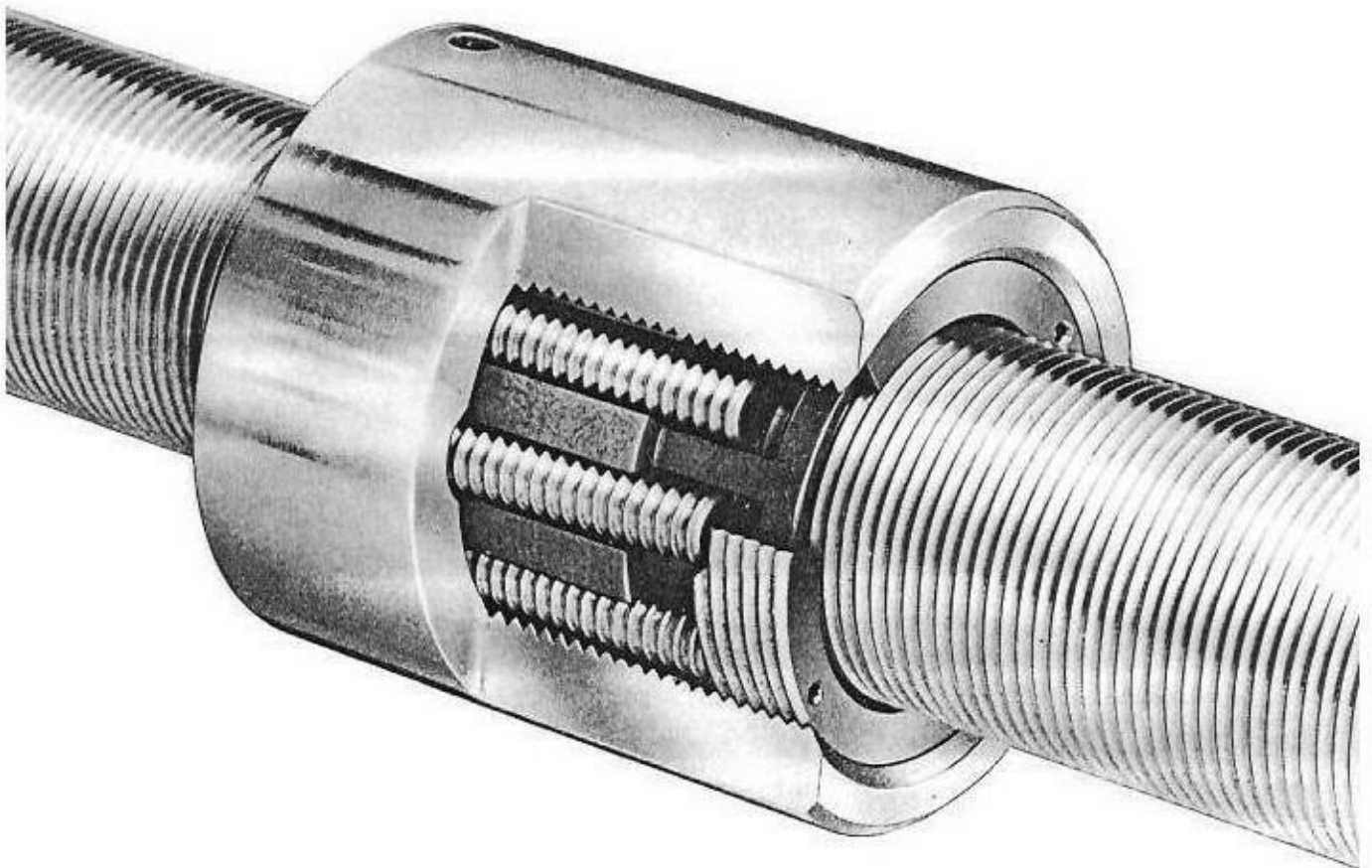

Electrically and hydraulically controlled machine

Technical Data

| | | |
|---------------------------|--|--|
| Machine Capacity | Width | 150 mm (6'') 200 mm (8'') 250 mm (10'') 300 mm (12'') |
| | Height | 150 mm (6'') |
| | Length | Unlimited |
| | Grinding Spindle | Motor up to 30 kW (40 HP) Spindle speed up to 3600 RPM |
| Belt Drive System | Motor | 1.2 kW |
| | Belt speed | 0 - 10 m/min. (0 - 393''/min.) (infinitely variable) |
| Electrics | Power Requirements | 380 V 50 Hz (230/460/3/60 Hz) |
| | Power consumption depending on machine equipment | up to 50 kW (66 HP) |
| | Control voltage | 110 volts |
| Pneumatic | Air pressure | 6 bar (60 PSI) minimum |
| Hydraulic System | Pressure | 60 bar |
| | Tank capacity | 23 liters |
| Standard Equipment | Grinding spindle with motor | |
| | Automatic wheel wear compensation | |
| | Air gauge adjustment system | |
| Accessories Available | Belt drive system with SCR motors | |
| | Grinding spindle motors with various horsepower | |
| | Grinding spindle brake | |
| | Magnetic chucks | |
| | Conveyor belts | |
| | Demagnetizing systems | |
| | Coolant systems | |
| | Dry grinding attachments | |
| | Turnover systems | |
| | Return conveyor systems | |
| Automatic loading systems | | |

Typical applications

Automatic grinding line for cutter blades (Hedge trimmers)

Material: Hardened steel

Sequence of operations:

- Automatic loading
- Grind first side
- Parts rinse
- Parts turn-over
- Grind second side
- Final rinse
- Drying
- Rust proofing
- Stacking

Rate of production:

450 parts/hour
500 mm (20")
length of part

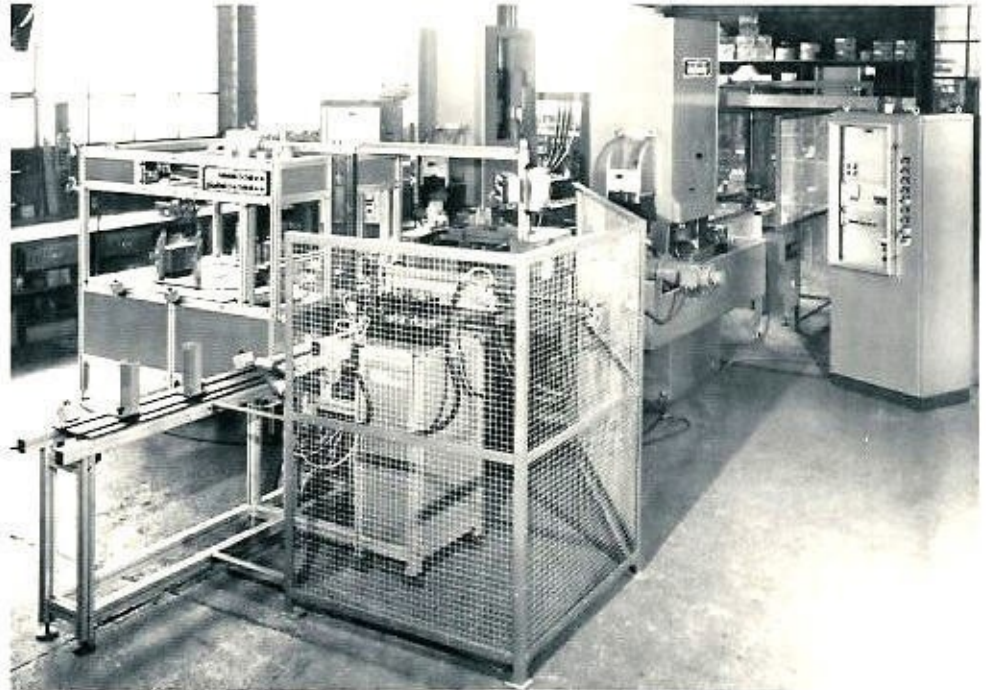

Grinding line for contactor armatures (E-Cores)

Material: Steel laminations

Sequence of operations:

- Semi-automatic loading
- Dry grinding, roughing and finishing (2 stations)
- Cleaning
- Rost proofing

Rate of production:

2500 parts/hour



A sample of many possible applications

The tungsten carbide insert $B = \frac{1}{2}''$

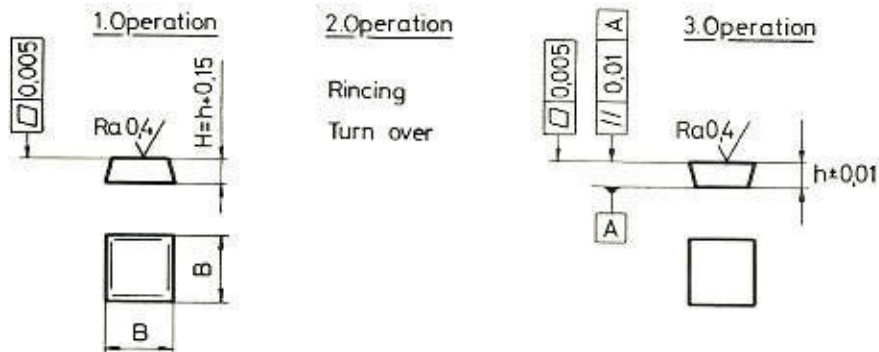

| | |
|--------------------|---|
| Workpiece | Tungsten carbide insert |
| Material | Tungsten carbide |
| Operation | Grinding of both sides bottom and cutting surface |
| Conveyor belt | Heat treated chromium steel belt |
| Clamping | Workpiece placed on conveyor and held in place by magnetic chuck |
| Grinding tool | Motorized spindle with roller bearing construction |
| Stock removal | till 0,3 mm/side (.01"/side) |
| Belt speed | 600 mm·min ⁻¹ (24"·min ⁻¹) |
| Stock removal rate | 2,25 cm ³ ·min ⁻¹ / line .14 inch cube·min ⁻¹ |
| Produktion | 2000 p/h per line |

| | |
|-----------|---|
| Equipment | Machine CES 1/100/4 SW |
| | Motorspindle 22 kW |
| | with infinitely variable speed from 1000 to 1800 RPM |
| | Frequency converter |
| | Heat treated chromium belt |
| | Permanentmagnetic plate on special table with adjustments of clearance at back of wheel |
| | Tungsten carbide guide rail |
| | Diamond wheel |



Through-Feed-Surface-Grinding

Abplanalp machines are in successful use in the world's largest and most demanding manufacturing industries.

Abplanalp machines, based on our world patent for through-feed-surface-grinding, range from simple single-station types to the most complex machining systems, equipped with handling robots and cleaning equipment. Several hundreds of these machines are successfully running in all the world's industrial countries, for customers ranging from sub-contractors to the biggest multinationals.



Our range includes:

- Single or double-station machines for roughing or finishing
- Machines with conveyor belt either 150 mm (6"), 200 mm (8"), 250 mm (10") or 300 mm (12") wide
- Machines with spindle power up to 40 kW (54 HP)
- Machines with spindle speeds 1000, (1200), 1500, 3000, (3600) RPM and more for diamond or CBN wheels.

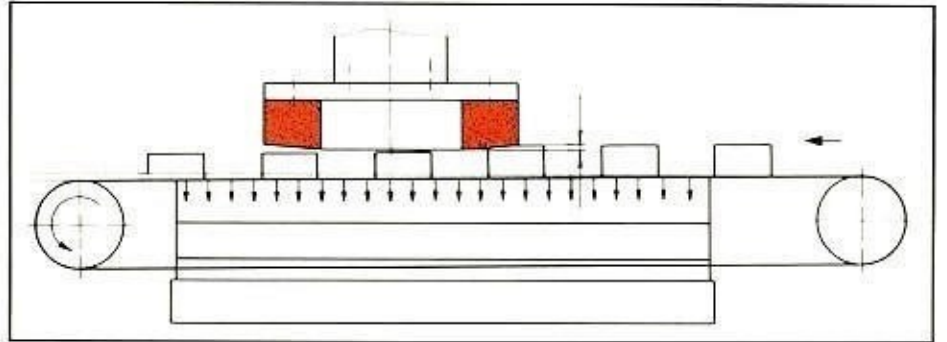

All machines can be supplied:

- with or without coolant feed
- for grinding magnetic or non-magnetic materials
- for grinding parts direct on the belt or in workholders with circulating transport system.

Options

All variants can be provided with loading and unloading stations and automatic turning devices including:

- demagnetizing devices
- coolant filtering and heat-extraction systems
- workpiece cleaning, washing and protective-coating plants.

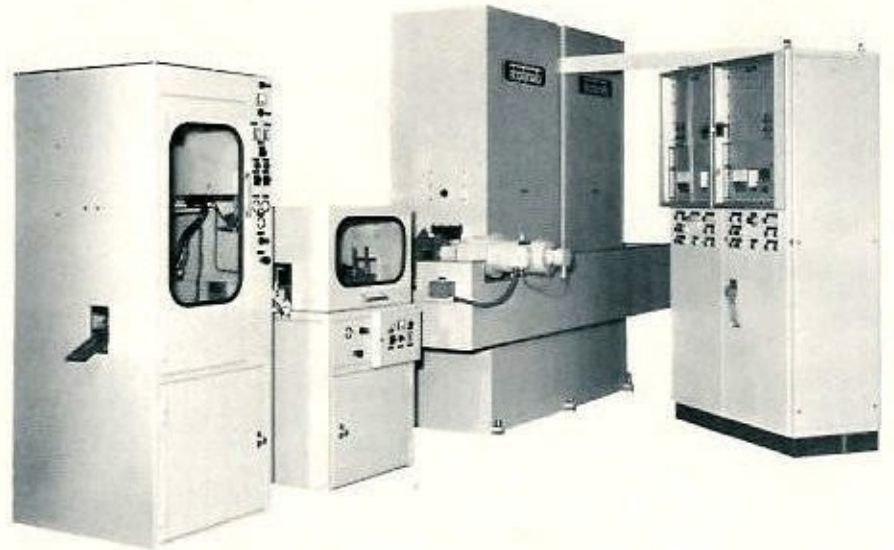

Photo: Grinding line for contactor armatures (E-cores)



Some Peripheral Equipment

Automatic handling

Abplanalp delivers the automatic handling equipment for any part and any requirement. A few examples are shown here.

Photo 1: Automatic loading of hedge-cutter blades

Photo 2: A loading robot for an ECMAS deburring machine

Photo 3: Automatic loading of small ground components from a vibrating hopper

Automatic turnover

Both in grinding and in deburring, components often require turning over in order to machine both faces, or according to the shape of the part.

Photo 4: Turnover device integrated in a through-feed-grinding machine for loudspeaker rings

Conveyor systems

We supply conveyor systems for grinding parts with circulating fixtures or transportation of parts.

Photo 5: This automatic transport system keeps the workholders for aluminium housings in continuous circulation through the grinding machine

Ultrasonic cleaning installations

For cleaning the parts after grinding or deburring.

Photo 6: View of ultrasonic through-feed tunnel for cleaning ferrite parts after grinding



1



2



3

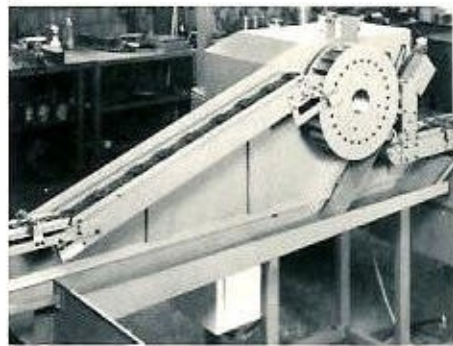

4



5



6

Please ask our advice regarding your specific grinding or deburring problems.

Representative:

ISELI PRECISION INC.



1405 MEGHAN AVENUE
ALGONQUIN, IL 60102

PH. 847-516-1110

www.iseliprecision.com

FAX: 847-658-1615

grinders@iseliprecision.com



abplanalp

ABPLANALP AG
 Machine Tools
 CH - 3292 Busswil
 Switzerland
 Tel. 032 / 84 29 13
 Telex 34 606

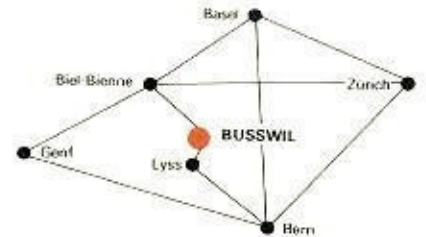

Exclusive represented by:

ISELI PRECISION INC. 

1405 MEGHAN AVENUE
 ALGONQUIN, IL 60102

PH. 847-516-1110 www.iseliprecision.com
 FAX: 847-658-1615 grinders@iseliprecision.com